

FICHE D'HOMOLOGATION /
HOMOLOGATION FORM

Homologation N°





054-CA-55



COMMISSION
INTERNATIONALE
DE KARTING - FIA



CARBURATEUR / CARBURETTOR

Constructeur / Manufacturer	DELL'ORTO spa
Marque / Make	Dell'Orto
Modèle / Model	PHBG 18 BS
Catégorie / Category	Group 3
Durée de l'homologation / Validity of the Homologation	2 ans / 2 years
Nombre de pages / Number of pages	7
La présente Fiche d'Homologation reproduit descriptions, illustrations et dimensions du carburateur au moment de l'homologation CIK-FIA.	This Homologation Form reproduces descriptions, illustrations and dimensions of the carburettor at the moment of the CIK-FIA homologation.
	
Photo côté aspiration / Photo of inlet side	Photo côté réglage / Photo of adjusting side
Signature et tampon de l'ASN / Signature and stamp of the ASN	Signature et tampon de la CIK-FIA / Signature and stamp of the CIK-FIA
	

Homologation N°

054-CA-55

Photo vue arrière / Photo view from behind



Photo côté oppose réglage / Photo opposite to adjusting side



Photo vue de dessus / Photo view from above



Photo vue de dessous / Photo view from underneath



Homologation N°

054-CA-55

Photo vue de dessus / Photo view from above (body)



Photo côté aspiration (vue additionnelle) /
Photo of inlet side (additional view)



Homologation N°

054-CA-55

Photo côté aspiration (vue additionnelle) /
Photo of outlet side (additional view)

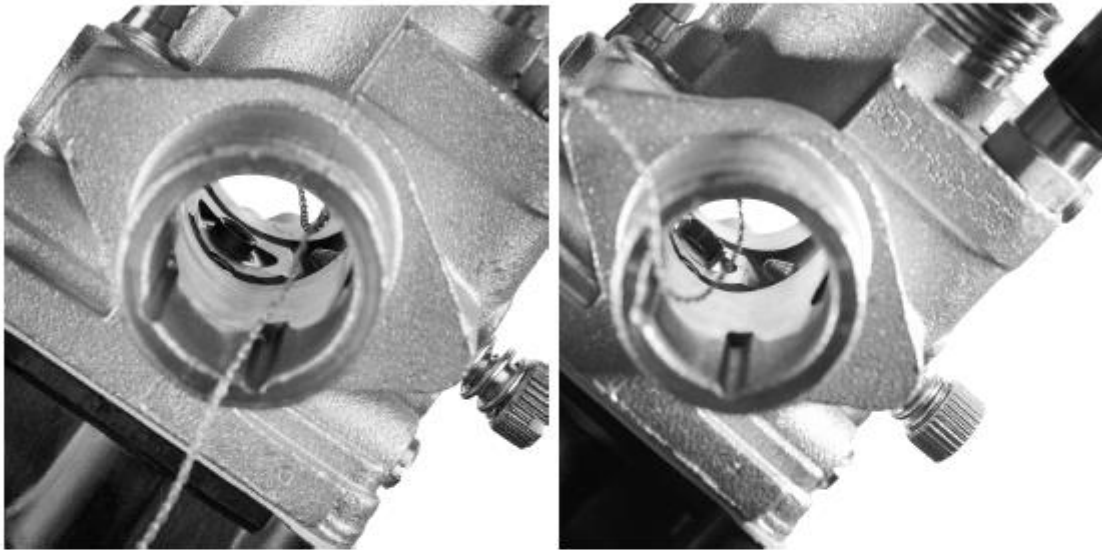
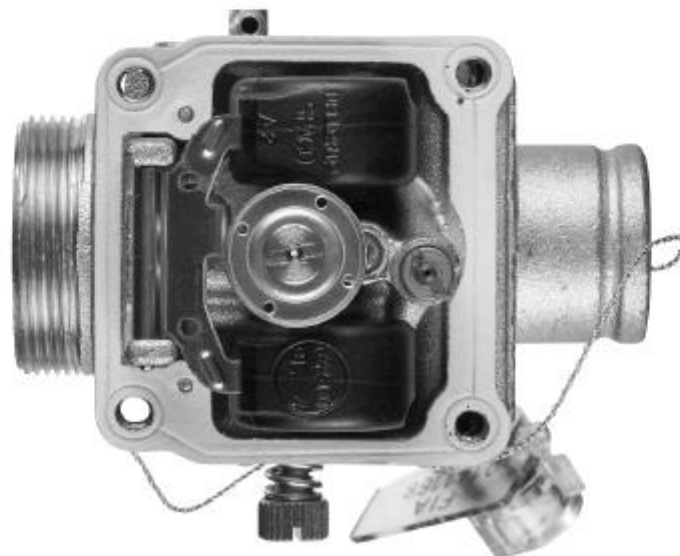

Photo vue de dessous (vue additionnelle) /
Photo view from underneath (additional view)



Homologation N°

054-CA-55

Description du carburateur et esquisse des pièces / Carburettor description and sketch of parts

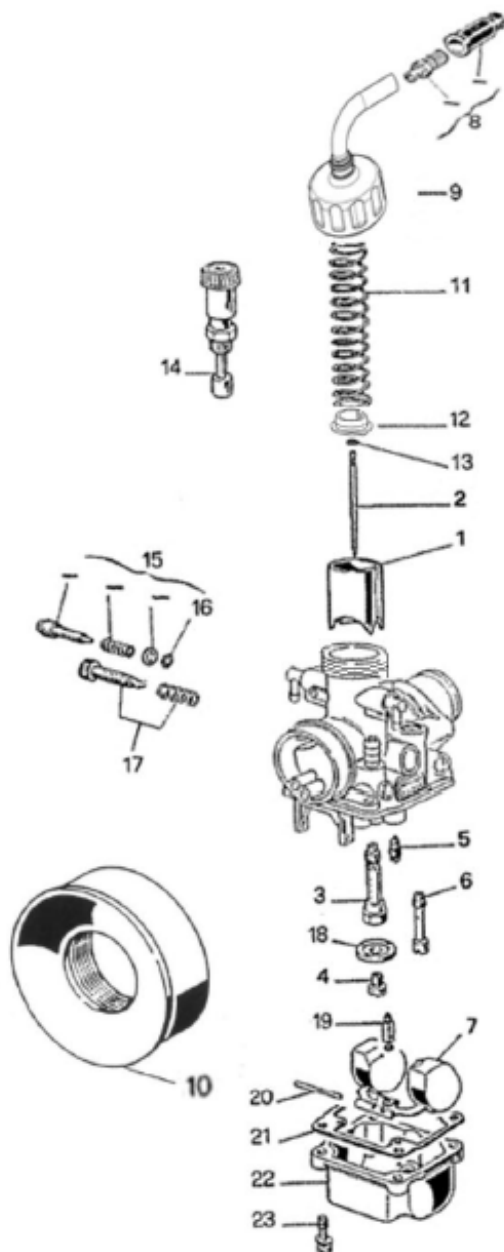

Homologation N°

054-CA-55

**Liste des pièces de rechange du carburateur PHBG 18 BS /
Parts list for carburettor PHBG 18 BS**

1	VOLET DE GAZ / GAS VALVE
2	AIGUILLE CONIQUE W / CONICAL NEEDLE W
3	PUITS DE AIGUILLE AN / AN NEEDLE JET
4	GICLEUR PRINCIPAL / MAIN JET
5	GICLEUR RALENTI / IDLE JET
6	GICLEUR STARTER / STARTER JET
7	FLOTTEUR 4 gr. / FLOAT 4 gr.
8	KIT DE REGLAGE VIS / ADJUSTING SCREW KIT
9	COUVERCLE / COVER
10	RACCORD D'ASPIRATION / CONNECTION
11	RESSORT / SPRING
12	DOUILLE DE RESSORT / PLATE
13	CLIP / CLAMP
14	STARTER / STARTER/CHOKE
15	KIT DE REGLAGE VOLET DE GAZ / IDLE ADJUSTING SCREW KIT
16	JOINT / GASKET
17	KIT REGLAGE RALENTI / GAS VALVE ADJUSTING SCREW KIT
18	COUPELLE DE FOND CUVE / PLATE
19	POINTEAU / NEEDLE
20	AXE DE FLOTTEUR / PIN
21	JOINT / GASKET
22	CUVE / BOWL
23	VIS / SCREW
Substitutions sont autorisées uniquement avec DELL'ORTO pieces originales / Replacement is allowed only with original DELL'ORTO parts	

Homologation N°

054-CA-55

